



STANDSCHLINGENTISCH KARLSRUHE

ANLEITUNG



Art.250163 - Art.250163A



ISTRUZIONI PER L'ASSEMBLAGGIO



NOTICE D'ASSEMBLAGE



INSTRUCTION FOR THE ASSEMBLY



MONTAGEANLEITUNG



Art.250163



Art.250163A



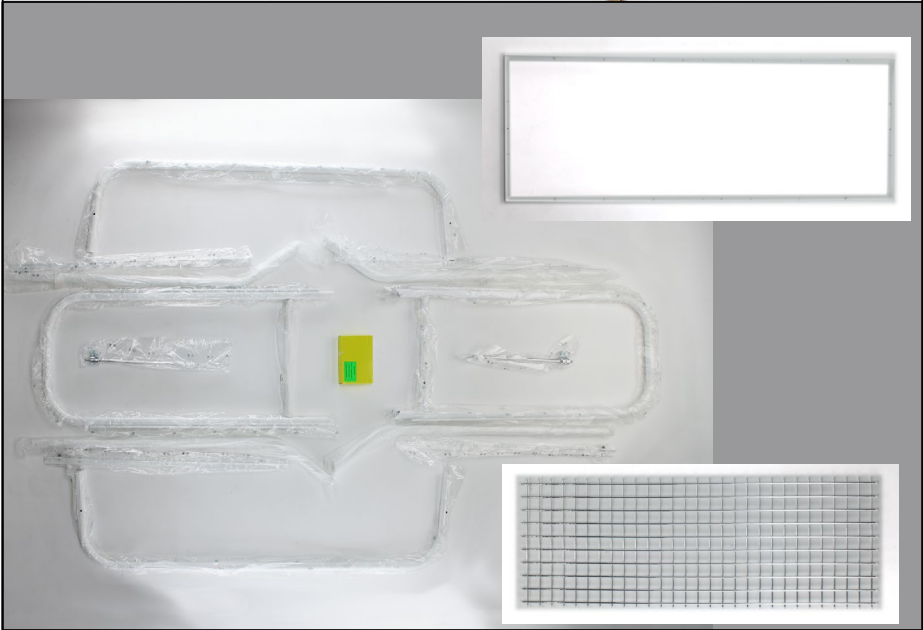

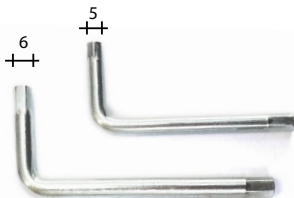
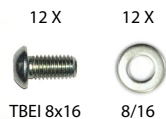
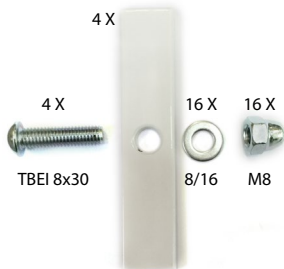
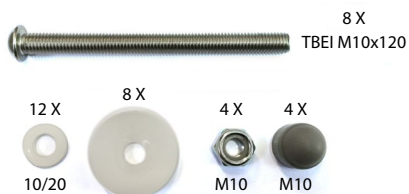
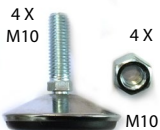
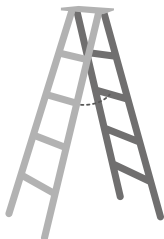
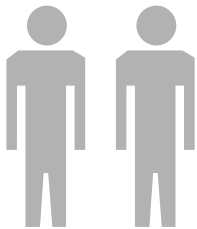



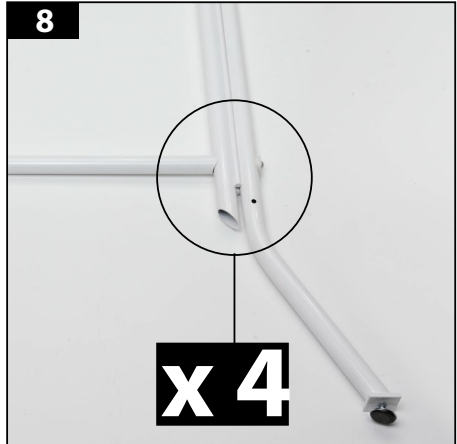
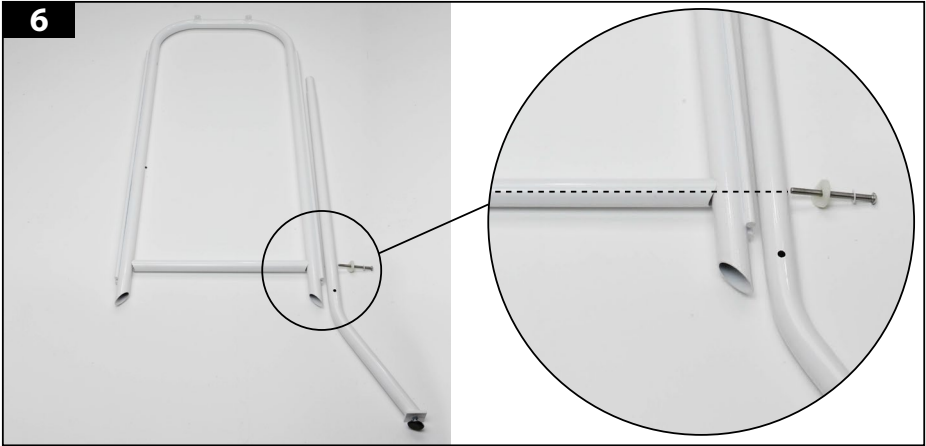

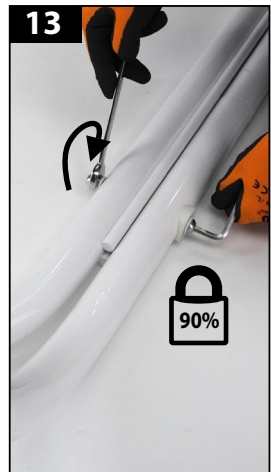



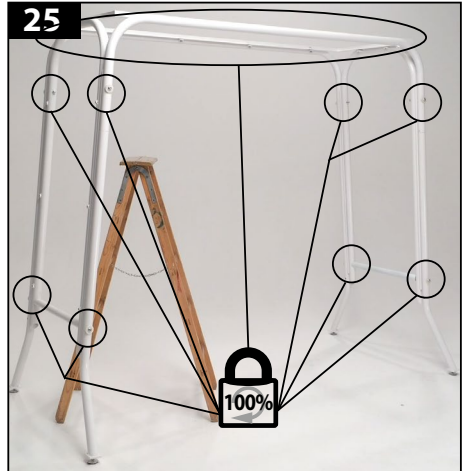

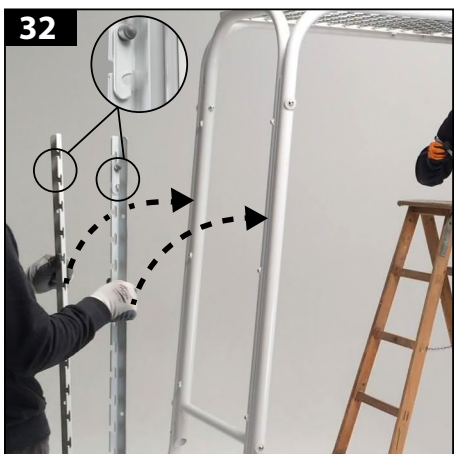
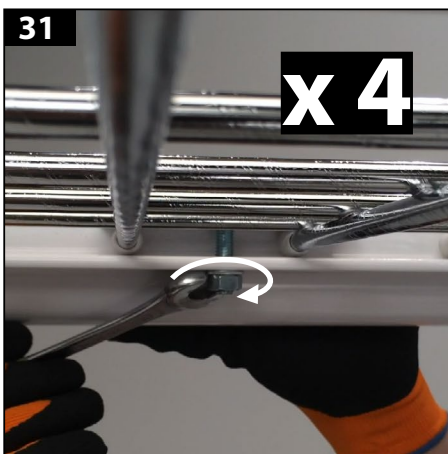

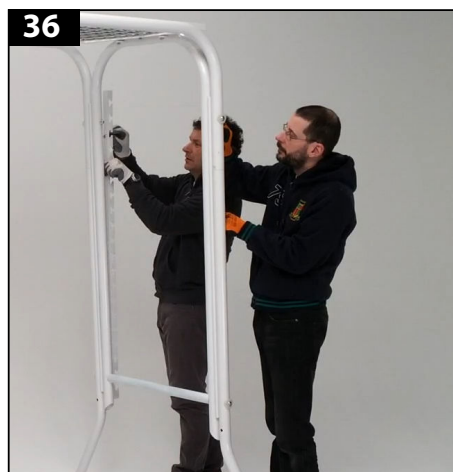
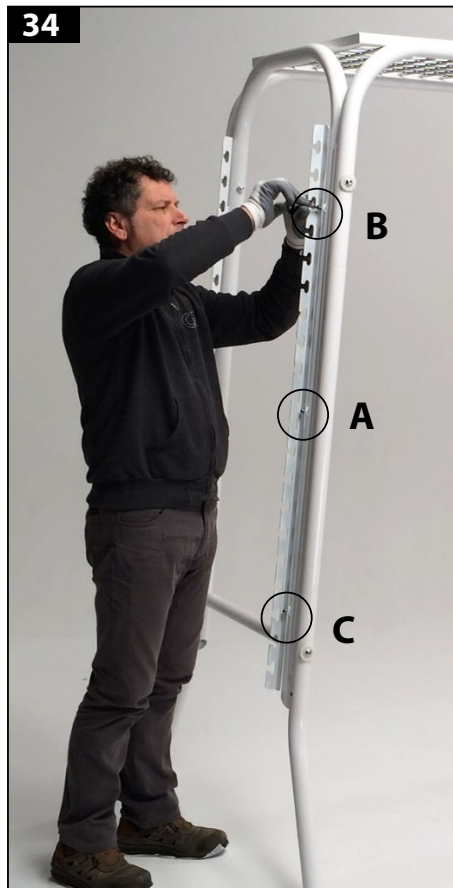
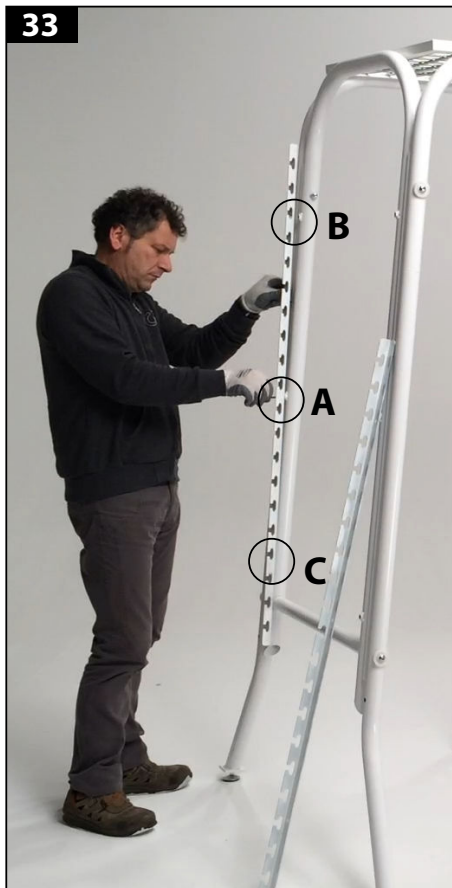

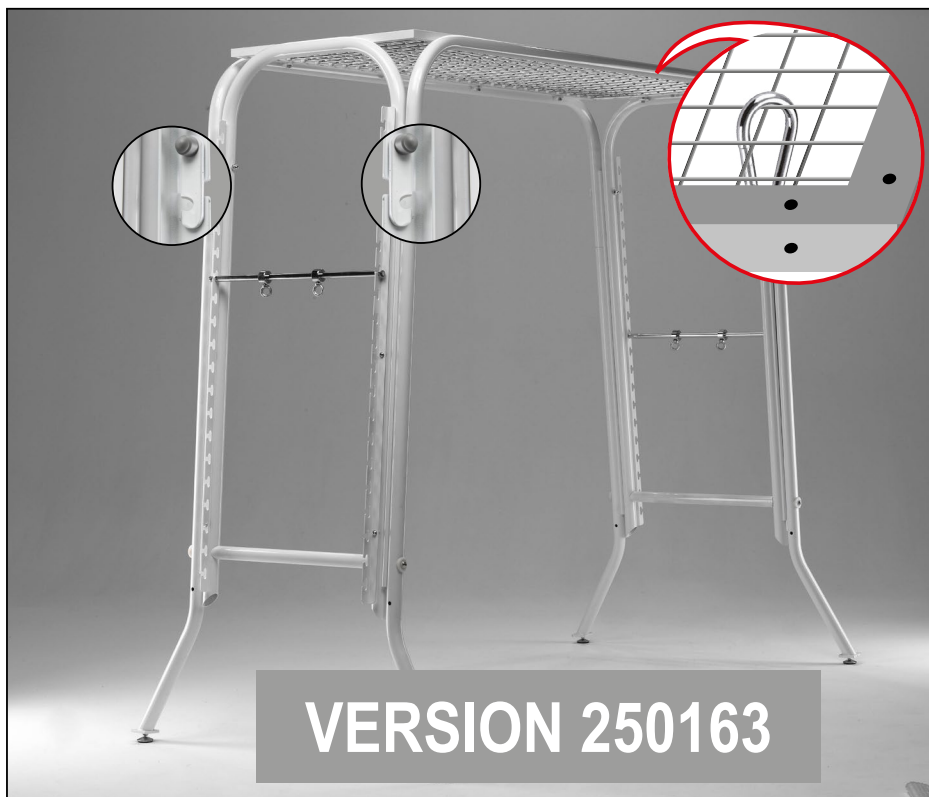
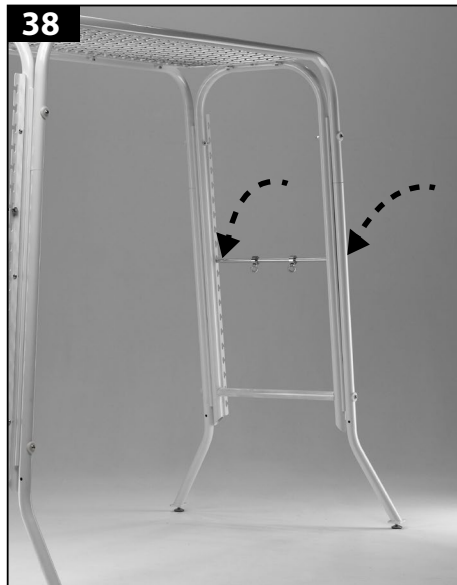



VERSION 250163A



39



40



41



42

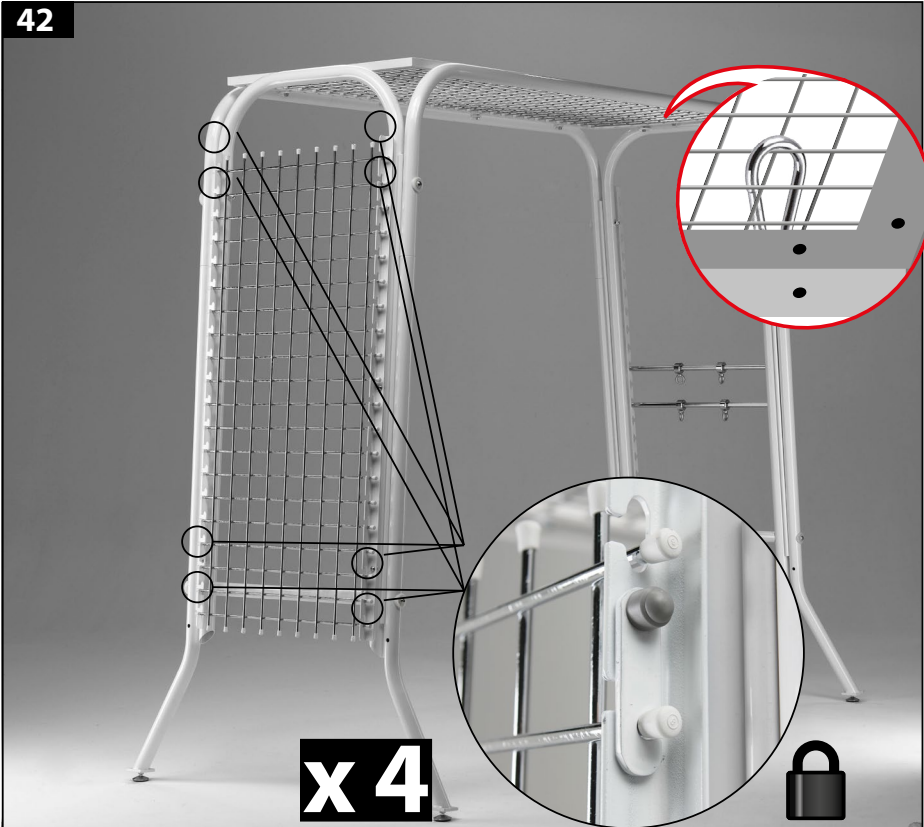



VERSION 250163



VERSION 250163A



CLASSIFICAZIONE ED USO

TORRE PER PULEGGIOTERAPIA: 250163, 250163A, 250163B

USO PREVISTO

Torre grigliata, di facile collocazione, il cui carico di lavoro in sicurezza di 300 Kg la rende adatta per accomodare pazienti imbracati. Accompagnare il percorso terapeutico e il recupero di pazienti il cui stato richiede la sistemazione in imbraco per un periodo lungo.

TIPO DI PAZIENTE

Obesi oppure traumatizzati con lesioni multiple o ustioni generalizzate che per l'estensione non possono essere accomodati in sistemazione classica.

LUOGO DI USO

Ospedali, cliniche.

OPERATORI ABILITATI ALL'USO

Operatori sanitari, professionisti, preparati allo scopo dalla struttura ospitante.

Sono sufficienti le istruzioni fornite al paziente dall'operatore sanitario di riferimento.

CONTROINDICAZIONI

Non adatto ad un utilizzo diverso da quello al quale il dispositivo è destinato.

ALTRE INDICAZIONI

- Non superare il carico di lavoro indicato.
- Il fabbricante declina ogni responsabilità per infortuni o danni provocati per l'errato impiego o scelta degli accessori scelti per il trattamento.



CLASSIFICATION ET UTILISATION

TOUR À POULITHÉRAPIE: 250163, 250163A, 250163B

UTILISATION PREVU

Tour grillagée, facile à installer, dont la charge de travail en sécurité de 300 kg lui permet d'accueillir des patients sanglés.

Accompagner le parcours de soins et la récupération de patients dont l'état nécessite la pose d'une sangle pendant une longue durée.

TYPE DE PATIENT

Obèses ou traumatisés avec des lésions multiples ou des brûlures généralisées ne pouvant être traitées de manière classique du fait de leur ampleur.

MILIEU D'UTILISATION

Hôpitaux, cliniques.

PROFESSIONNELS HABILITES A L'UTILISATION

Professionnels de santé et utilisateurs préparés à la mission par la structure d'accueil.

Les instructions transmises au patient par le professionnel de santé de référence suffisent.

CONTRE-INDICATIONS

Non adapté à une utilisation autre que celle pour laquelle le dispositif est conçu.

AUTRES INDICATIONS

- Ne pas dépasser la charge de travail indiquée.
- Le fabricant décline toute responsabilité en cas de blessures ou de dommages provoqués par une mauvaise utilisation du produit ou un mauvais choix des accessoires utilisés pour les soins.



CLASSIFICATION AND USE

TRACTIONTHERAPY TOWER: 250163, 250163A, 250163B

INTENDED USE

Easily-positioned grid tower with safe workload of up to 300 kg, making it perfect for use with harnessed patients. Assist with the treatment and recovery of patients needing to be in a harness for a long period of time.

TYPE OF PATIENT

Obese or with multiple injuries or widespread burns meaning that they cannot be accommodated in a standard system.

PLACE OF USE

Hospitals and clinics.

OPERATORS QUALIFIED TO USE THE PRODUCT

Healthcare professionals specifically trained by the host facility.
The instructions given to the patient by the reference healthcare professional suffice.

CONTRAINDICATIONS

Not suitable for use in any way other than the intended purpose.

OTHER INDICATIONS

- Do not exceed the workload indicated.
- The manufacturer refuses all liability for any injury or damage caused through the incorrect use or choice of accessories for treatment.



KLASSIFIKATION UND NUTZUNG

TRAKTIONTHERAPIE-TURM: 250163, 250163A, 250163B

VORGESEHENE VERWENDUNG

Leicht aufzustellender Gitterturm, der mit seiner sicheren Arbeitslast von 300 kg für die Aufnahme von vergurteten Patienten (mit Gurtzeug) geeignet ist. Begleitung des Therapieverlaufs und Rehabilitation von Patienten, deren Zustand eine langfristige Therapie mit Gurten erfordert.

ARTS DES PATIENTEN

Patient mit traumatischen Erkrankungen der oberen und unteren Gliedmaßen, die nicht signifikant sind und deren Behandlung voraussichtlich nur kurz sein wird.

VERWENDUNGSORT

Krankenhäuser und Kliniken.

ZUR VERWENDUNG BERECHTIGT

Mitarbeiter des Gesundheitswesens, Fachleute, die von der Aufnahmeeinrichtung für diesen Zweck ausgebildet wurden.
Die vom behandelnden Gesundheitspersonal an den Patienten erteilten Anweisungen sind ausreichend.

KONTRAINDIKATIONEN

Nicht geeignet für eine andere Verwendung als die, für die das Gerät vorgesehen ist.

WEITERE HINWEISE

- Die angegebene Arbeitsbelastung nicht überschreiten.
- Der Hersteller lehnt jegliche Haftung für Unfälle oder Schäden ab, die durch unsachgemäßen Gebrauch oder die falsche Wahl des Zubehörs für die Behandlung verursacht werden.

TARGHETTA DI IDENTIFICAZIONE - PLAQUE D'IDENTIFICATION - IDENTIFICATION LABEL - IDENTIFIZIERUNGSSCHILD



FERROX s.r.l.
Via del Lavoro, 9 Z.I.
31013 Codognè (TV) - Italia
Tel. +39 0438 777099
Fax +39 0438 777091
www.ferrox.it - info@ferrox.it

MD	MODEL
REF	YYYY
SN	XXXXXX
	YY/MM/DD
	= 140Kg







MADE IN ITALY

UDI 



(01)0805347043YYYY(11)YYMMDD(21)XXXXXX

Rev.02 del 03/20

Simbolo o Sigla	Descrizione	Description	Description	Beschreibung
MD	Dispositivo Medico	Dispositif Médical	Medical Device	Dies ist ein Medizinprodukt
REF	Identificativo catalogo	Identifiant catalogue	Catalogue Number	Katalognummer
SN	Numero di serie	Numéro de série	Serial Number	Seriennummer
	Identificazione fabbricante	Identification du fabriquant	Manufacturers name	Names des Herstellers
	Data di fabbricazione	Date de fabrication	Date of manufacture	Herstellungsdatum
 	Portata massima	Charge de travail en sécurité	Safety work load	Sichere Arbeitslast
	Consultare le istruzioni per l'uso	Consulter le mode d'emploi	Read the manual	Anteilung lesen
CE	Marchio di conformità CE MDR 2017/745	Marque de conformité CE MDR 2017/745	CE mark MDR 2017/745	CE – Kennzeichen MDR 2017/745
UDI	Identificazione unica del dispositivo	Identification Unique des Dispositifs Médicaux	Unique Device identification	Einmalige Produktkennung



Management
System
ISO 13485:2016
ISO 9001:2015



www.tuv.com
ID: 300004046



Stabilimento e sede legale:

via del Lavoro Z.I.

31013 Codogné (TV) Italia

Tel. +39 0438 777099 - 778370

Fax +39 0438 777091

P.IVA: IT 03613220262

e-mail: info@ferrox.it

www.ferrox.it



==== www.sport-tec.de ====

Sport-Tec GmbH
Physio & Fitness
Lemberger Str. 255
D-66955 Pirmasens

Tel.: +49 (0) 6331 1480-0
Fax: +49 (0) 6331 1480-220
E-Mail: info@sport-tec.de
Web: www.sport-tec.de

