



NOHRD SEILZUGAPPARAT SLIMBEAM

ANLEITUNG

Art.-Nr.  22793 · Kategorie:  Seilzüge



SlimBeam
Aufbauanleitung
Assembly Manual



Tablethalterung
optional erhältlich
*Optional electronic
training guide*



Video-Anleitung
Video Instruction

www.nohrd.com/videos



Inhalt <i>Content</i>	Seite/n <i>Pages</i>
Produktdetails / Hinweise <i>Production details / General Information</i>	3
Sicherheitshinweise <i>Safety Instructions</i>	4-5
Handhabung <i>Handling Instructions</i>	6-7
Montagehinweise / Service <i>Assembly Instructions / Service</i>	8-9
Teileliste <i>Parts</i>	10-11
Aufbauanleitung <i>Assembly</i>	12-31
Wartung <i>Maintenance</i>	32-33
Übersetzung ändern <i>Gearing</i>	34-37
Zubehör <i>Accessories</i>	38-40

**Modellbezeichnung:**

SlimBeam

Maße, Gewicht:

Breite: 40 cm

Höhe: 215 cm

Tiefe: 20 cm

Gewicht: ca. 120 kg

Materialien:

Holz, Kunststoff, Metall

Anlieferung:

Lieferung in 4 Kartons

Funktionen / Anwendungsbereich:

Seilzug für das Ganzkörpertraining

**Wichtige Hinweise:**

Holz ist ein Naturmaterial und kann bei der Benutzung Geräusche von sich geben.

Vorsicht vor Splittern. Das Holz kann Unregelmäßigkeiten in der Farbe und in der Form haben. Dies ist kein Grund zur Beanstandung. Das Holz reagiert auf Umwelteinflüsse, es arbeitet. Daher empfehlen wir die Schrauben regelmäßig zu prüfen und ggfs. fest zu ziehen.

Wir empfehlen den Zusammenbau mit zwei Personen vorzunehmen. Achten Sie auf genügend Platz zum Aufbauen. Wir empfehlen das Verpackungsmaterial aufzubewahren. Bei nicht Aufbewahrung bitte fachgerecht entsorgen.

Warnhinweis:

Nicht geeignet für Kinder unter 36 Monaten, da Erstickungsgefahr wegen verschluckbarer Kleinteile!
Vorsicht vor Gewichten!
Max. Benutzergewicht der Klimmzugstange: 130 kg.

Modell:

SlimBeam

Measurements:

Width: 40 cm

Height: 215 cm

Depth: 20 cm

Weight: 120 kg

Materials:

Wood, Plastics, Metal

Delivery:

Delivery in 4 boxes

Function:

Cable pull for full-body workout

Important Notes:

Wood is a natural material that can wear and tear and make noises during the use of the machine. Wood can cause splinters. Wood can show irregularities in the pattern, colour and in shape. These are no reasons for a complaint. Wood can react to outer influences and wood is in constant move. It is essential to check all fittings regularly and before use of the product.

We recommend assembling the unit with two grown up handy people. Make sure you have enough space to build the product. We recommend keeping the packaging material until the unit is in satisfactory use.

WARNING:

This product is not suited for children under the age of 36 months as it contains small parts that can be swallowed. Children are allowed only to use this product under the surveillance of a grown up person. The chin-up bar is not suitable for body weight more than 130 kg.

Sicherheitshinweise:

Bitte lesen und beachten Sie unbedingt die folgenden Hinweise zur Handhabung, zum Umgang mit dem Gerät sowie zur Wartung des Gerätes.

Bitte bewahren Sie diese an geeigneter Stelle auf, um im Bedarfsfall nachschlagen zu können.

Bei Beachtung der Sicherheitshinweise sowie der Montage- und Inbetriebnahme-Anleitung ist der Betrieb des Gerätes sicherheits-technisch unbedenklich.

1. Das Gerät ist für ausgewachsene Personen bestimmt und darf nur für den bestimmungsgemäßen Zweck des Körpertrainings verwendet werden. Wird dies nicht beachtet, kann der Hersteller durch nicht bestimmungsgemäßen Gebrauch nicht verantwortlich gemacht werden.

2. Die Sicherheit kann durch beschädigte Bauteile beeinträchtigt sein. Deshalb unterlassen Sie die Verwendung des Gerätes im Falle, dass eines der Originalbauteile nicht funktionsfähig, beschädigt oder verschlissen ist. Ersetzen Sie das defekte Teil nur mit Original-Ersatzteilen vom Hersteller.

3. Bei falsch ausgeführten Reparaturen oder Ersatzteilen, die nicht vom Hersteller stammen, können Gefahren entstehen.

4. Selbstständige Eingriffe oder Manipulationen des Gerätes können zu Beschädigungen oder Beeinträchtigungen in der Nutzung führen oder sogar gesundheitliche Schäden zur Folge haben. Änderungen am Gerät sollten ausschließlich von Fachpersonal durchgeführt werden.

5. Holz ist ein natürliches Material und gibt dem Druck von Schrauben leicht nach. Ziehen Sie deshalb regelmäßig (mindestens alle 2 Monate) die Verbindungsschrauben mit den mitgelieferten Werkzeugen nach. Kontrollieren Sie das Gerät auf Fehler.

6. Alle Personen, vor allem Kinder, sind auf die Gefahren der Nutzung des Gerätes vorher hinzuweisen. Kinder sollten das Gerät nie ohne Aufsicht einer erwachsenen Person nutzen.

7. Konsultieren Sie vor Nutzung des Gerätes Ihren Hausarzt und überprüfen Sie Ihren Gesundheitszustand. Die falsche körperliche Nutzung des Gerätes kann zu Gesundheitsschäden führen. Vor allem die übermäßige körperliche Beanspruchung kann gefährlich sein. Bauen Sie Ihr Trainingsprogramm über einen längeren Zeitraum auf.



Safety Instructions:

Please carefully read the following safety instructions for the correct use, handling and maintenance of your new fitness equipment. Keep this manual in case you need it later again. When following these instructions carefully, your equipment will be safe at any time in use.

1. This machine is meant to be used by grown up's only. This machine is a tool to improve physical fitness and should be used only for this purpose. If this is neglected the manufacturer can not be made liable.

2. Damaged parts can affect the safety of this machine. You should not use the machine if one or several original parts are damaged, worn or not fully functional. Replace the default part with original parts only.

3. Incorrect repair work or spare parts that are not from the manufacturer can lead to danger and damages. In this case the manufacturer can not be made liable.

4. Manipulation or changes from the original design of the machine can lead to damages and/or physical injuries. Changes of the machine should only be carried out by professional employees from the manufacturer.

5. Wood is a natural material. The fixation screws leave marks on the wood. Due to the softness of the wood the screws have to be tightened on a regular (minimum every two months) basis. Use the tools that you received with the machine. During this action control the machine on damages and default parts.

6. All people that use this machine, mainly children, have to be informed and alerted to these security alerts before use. Children should never use the machine without the surveillance of a competent grown up.

7. Before you start using the machine make sure that you are in good physical and conditional health. Consult your doctor. The wrong usage of the machine and mainly the excessive work out can lead to health damages. Build up your training slowly.

Handhabung:

Bitte lesen Sie diese Handhabungshinweise sorgfältig durch! Die hier genannten Informationen helfen Ihnen, das Gerät richtig zu verwenden und zu warten.

1. Nehmen Sie das Gerät erst in Betrieb, wenn die Montage komplett und nach Anleitung erfolgt ist.

2. Erlernen Sie vor dem ersten Training die Einstellungsmöglichkeiten des Gerätes und nehmen Sie die für Ihre physischen Gegebenheiten richtigen Einstellungen vor.

3. Vergewissern Sie sich vor jedem Training, dass die Schrauben gut angezogen sind.

4. Stellen Sie das Gerät an einem trockenen Ort auf. In Feuchträumen können Metallteile des Gerätes rosten.

5. Nach jedem Training sollte das Gerät mit einem feuchten und frischen Tuch abgewischt werden. Insbesondere Laufschiene und Handgriffe sind dabei zu reinigen. Verwenden Sie für die Reinigung niemals aggressive oder ätzende Reinigungsmittel.

6. Kinder sollten das Gerät niemals ohne Beaufsichtigung einer erwachsenen Person nutzen. Während des Trainings hat der Trainierende dafür zu sorgen, dass keine andere Personen (insbesondere Kinder) den Trainingsablauf stören oder in das Gerät greifen.

7. Für das Training empfehlen wir geeignete Trainingskleidung und Trainingsschuhe.

8. Sollte das Holz durch Schuhe oder andere Gegenstände verunreinigt sein, empfehlen wir Ihnen unser Pflegeset. Die Verunreinigung kann mit dem Schleifvlies entfernt werden und anschließend wird die Stelle neu geölt. Verwenden Sie nur Original-Öl des Herstellers.



Handling Instructions:

Please read these handling instructions carefully. The following information will help you to use the machine correctly.

- 1. Start using the machine only after fully assembling and completely read and understood the safety instructions.*
- 2. Learn about all different adjustments possibilities your machine has. Adjust the machine to your physical conditions.*
- 3. Check all fixings before using the machine.*
- 4. Store the machine in a dry area. Humidity (Swimming pool area or similar) can lead to corrosion of metal parts.*
- 5. After every work out the machine has to be cleaned with a moist cloth. Mainly rails and moving parts like pulleys and handle should be cleaned. Do not use chemicals as they can damage the surface of the material.*

6. Children are not allowed to use the machine without the surveillance of a grown up. During the work out you have to make sure that no other people (mainly children) are disturbing you or reach into moving parts of the machine. Moving ropes, bungees, weight stacks or other moving parts can lead to severe physical damages.

7. For the work out we recommend to wear suitable training clothes and training shoes (sneakers)

8. For maintaining the wood parts of your machine we recommend the use of our maintenance kit.



Montagehinweise:

Packen Sie das Gerät zuerst komplett aus und überprüfen Sie, ob Transportschäden vorliegen. Das Verpackungsmaterial sollte erst nach kompletter Montage und zufriedenstellender Inbetriebnahme des Gerätes fachgerecht entsorgt werden, da dieses eventuell als Transportverpackung für Rücksendungen dienen kann.

Prüfen Sie die Vollständigkeit der Lieferung. Den Lieferumfang entnehmen Sie der nachstehenden Teilliste. Sollten Teile fehlen oder defekt angeliefert sein, wenden Sie sich bitte an den Fachhändler oder den Hersteller.

Sie sollten genügend Platz für den Aufbau haben und die Montage sollte ausschließlich durch eine erwachsene Person durchgeführt werden. Im Zweifelsfall nehmen Sie die Hilfe einer weiteren erwachsenen, technisch begabten Person hinzu. Lesen Sie zuerst die Montageanleitung durch.

Montieren Sie das Gerät nach Montageanleitung und folgen Sie der Bebilderung. Achten Sie auf Hinweise bei den Bildern. Kontrollieren Sie nach vollständiger Montage alle Schraubverbindungen nochmals sorgfältig.

Service:

Für Serviceanfragen benötigen Sie die Seriennummer des Gerätes.

Diese befindet sich unten am Bracket.

Bitte geben Sie die Seriennummer bei Serviceanfragen immer mit an.

Serviceadresse:

WaterRower GmbH
Otto-Hahn-Straße 75
48529 Nordhorn

Telefon 0 59 21 - 17 98 400

info@nohrd.de
www.nohrd.de



Assembly Instructions:

Unpack your machine carefully and check on transportation damages. Keep the packaging material until you successfully assembled the machine and until you have satisfactorily taken the machine into use.

Check the completeness of the delivery. The delivery contents are listed on the parts list in this manual. If you find damaged parts or if parts are missing, please contact your local dealer or the manufacturer.

Make sure you have enough space to complete the assembly. The assembly should be done by at least one grown up person. Help from a technical averse is recommended.



























Assemble the machine by following the steps in the manual. Read and follow carefully the alerts. Recheck all fixings after having completed the assembly. Machines that require wall assembly can only be assembled on solid stone/concrete walls. Plywood or plaster walls are not suitable.

Service:

For service questions you need your serial number, which can be found on the metal bracket (E).

*WaterRower GmbH
Otto-Hahn-Straße 75
48529 Nordhorn
GERMANY
Telefon +49 (0) 59 21 - 17 98 400*

*info@nohrd.de
www.nohrd.de*

	A 1x		M 1x
    	B 1x		N 2x
	C 1x		O 7x
	D 14x		P 8x
	E 1x		Q 2x
	F 1x		R 6x
	G 2x		S 2x
 	H 2x		T 1x
	I 1x		U 1x
	J 1x		V 1x
	K 1x	  	W 1x
	L 1x		

A 1x	Korpus <i>Corpus</i>	M 1x	Rückplatte <i>Backplate</i>
B 1x	Butterfly <i>Butterfly</i>	N 2x	Schwarze Schraube (40 mm) <i>Black bolt (40 mm)</i>
C 1x	Mitnehmerstange + Gewicht <i>Guide rod with starter weight</i>	O 7x	Silberne Schraube (25 mm) <i>Silver bolt (25 mm)</i>
D 14x	Gewichte <i>Weights</i>	P 8x	Madenschraube <i>Maggot screw</i>
E 1x	Metallverbindungsplatte <i>Metal bracket</i>	Q 2x	Silberne Schraube (40 mm) <i>Silver bolt (40 mm)</i>
F 1x	Bodenplatte <i>Baseplate</i>	R 6x	Kurze Schraube (15 mm) <i>Short bolt (15 mm)</i>
G 2x	Wandhalterung <i>Wall mounting bracket</i>	S 2x	Wandmontage-Set <i>Wall mounting set</i>
H 2x	Gewichtsführungsstange <i>Weight guide rod</i>	T 1x	Gummistopper <i>Rubber stopper</i>
I 1x	Führungsstange <i>Main guide rod</i>	U 1x	Zugseil (für 3:1 Übersetzung) <i>Cable (for 3:1 gearing)</i>
J 1x	Stahlplatte oben <i>Metal plate (top)</i>	V 1x	Gewichtsverstellungs-Pin <i>Weight pin</i>
K 1x	Stahlplatte unten <i>Metal plate (bottom)</i>	W 1x	Zubehör <i>Accessories</i>
L 1x	Spanner <i>Spanner bracket</i>	X 2x	Stopper <i>Damper</i>

1

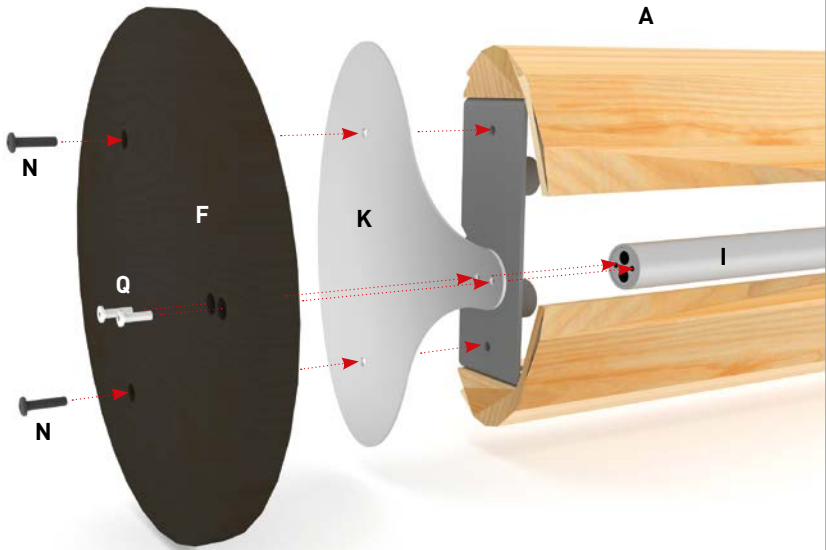



Schritt 1

Legen Sie den Korpus **(A)** flach auf den Boden oder auf die leere Verpackung und achten Sie darauf, dass dieser dabei nicht verkratzt. Montieren Sie nun die ovale, anthrazite Stahlplatte **(K)** und die schwarze runde Fußplatte **(F)** an den Korpus **(A)** und an der Führungsstange **(I)**. Nutzen Sie hierzu das abgebildete Montagematerial und ziehen Sie die Schrauben fest an.

ACHTUNG: Die Führungsstange **(I)** wird mit 2 Schrauben **(Q)** befestigt!
Die beiden ovalen Stahlplatten (K + J) sind unterschiedlich.

Stellen Sie anschließend das Gerät auf.

Step 1

Lay the corpus (A) on the floor or on the empty box and make sure you don't scratch it. Mount the oval anthracite metal plate (K) and the black baseplate (F) to the corpus (A) and the main guide rod (I). Use the screws specified for this step and tighten them thoroughly.

ATTENTION: The main guide rod is fixed with two screws (Q) to the oval plate and the baseplate. The two oval plates are different. Make sure you take the right one!

2

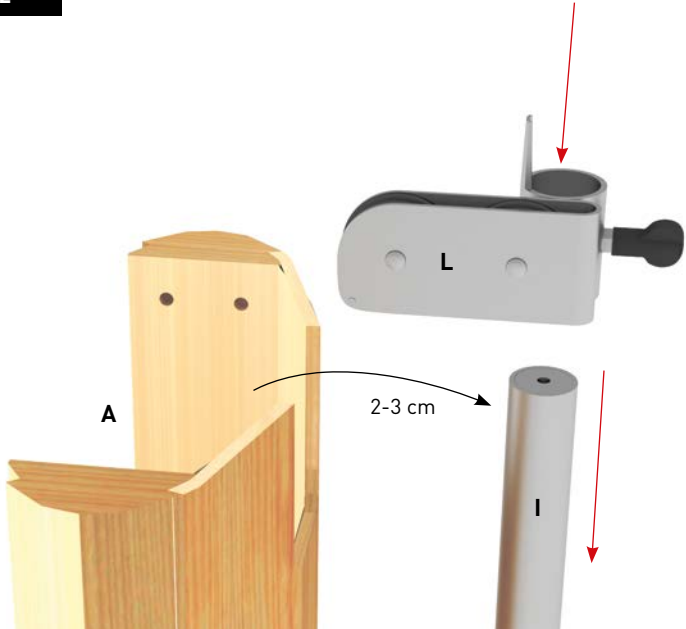

2.1



2.2

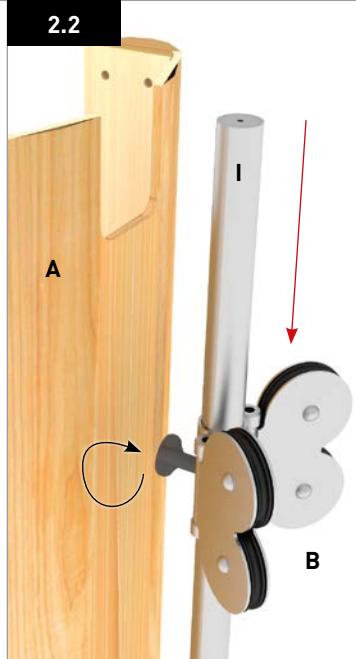

Schritt 2

Führen Sie den Spanner **(L)** auf die Führungsstange **(I)**.
Durch leichtes Vorziehen (2-3 cm) der Führungsstange **(I)** können Sie den Spanner bis ca. 10 cm über der Bodenplatte **(F)** schieben. Fixieren Sie vorerst den Spanner an dieser Position (Abb. 2.1).

ACHTUNG: Die Laufrollen des Spanners **(L)** befinden sich nun links von der Führungsstange **(I)**. Achten Sie darauf, dass die vorderste Rolle sich innerhalb der Aussparung des Korpus **(A)** befindet (der Korpus sollte nicht vom Spanner berührt werden).

Führen Sie nun den Butterfly **(B)** auf die Führungsstange **(I)** und fixieren Sie diesen ca. in der Mitte der Führungsstange **(I)** (Abb. 2.2).

Hinweis: Die Fixierschraube am Butterfly sollte sich hinter der Führungsstange befinden.

! Achtung: Beachten Sie die Wartungs-Hinweise auf den Seiten 32-33 zur Pflege des Butterflys und der Gewichtsführungsstangen.

Step 2

Slide the spanner bracket (L) onto the main guide rod (I). By softly pulling the main guide rod forward you will be able to slide the spanner bracket all the way down. Fix the spanner bracket approximately 10 cm above the baseplate (figure 2.1).

ATTENTION: The pulleys of the spanner bracket are on the left hand side of the main guide rod (I).

Slide the butterfly (B) onto the main guide rod (I) and fix it approximately in the middle (figure 2.2).

ATTENTION: The fixing screw of the butterfly is located at the back of the main guide rod.

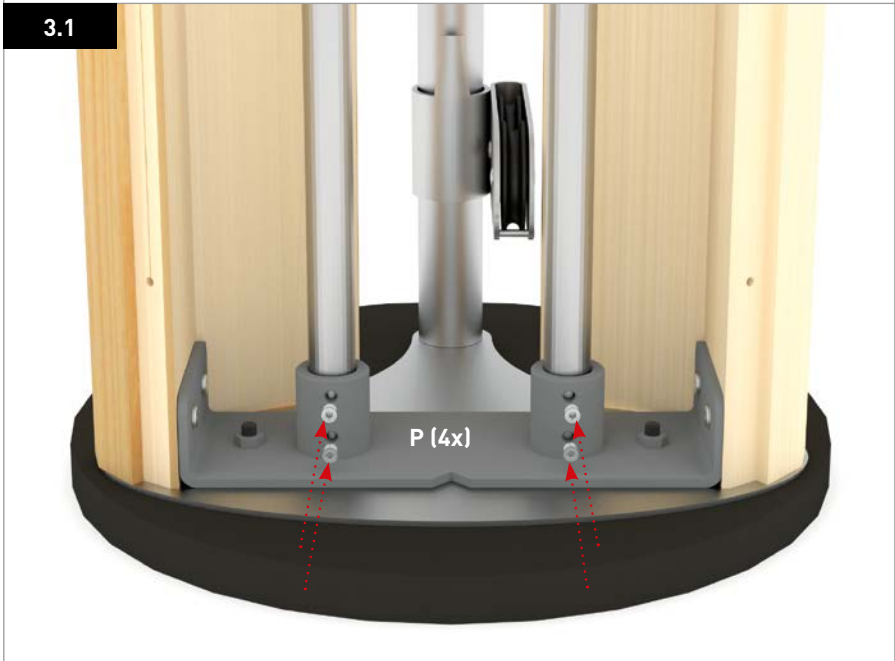
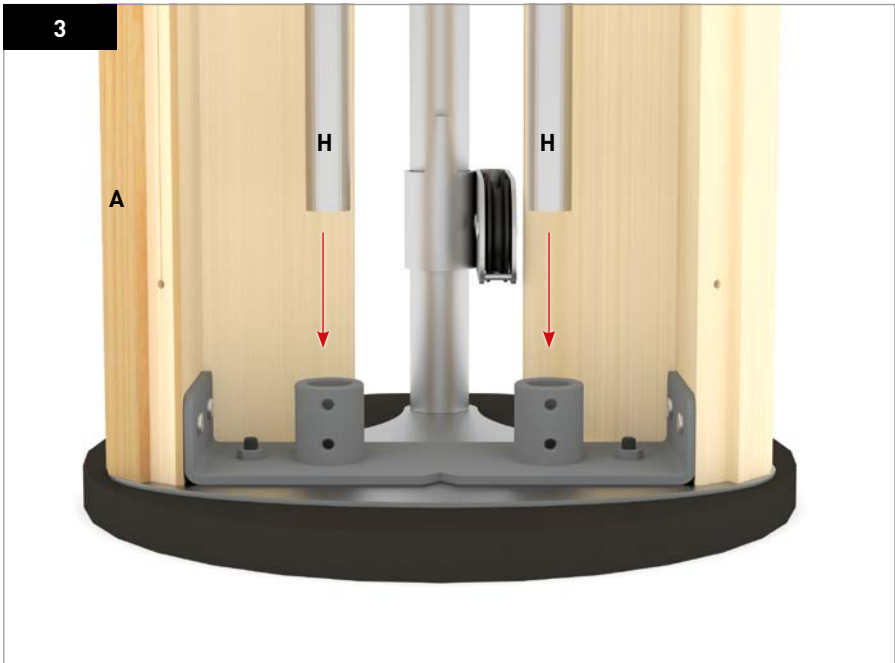



Schritt 3

Setzen Sie jetzt die beiden Gewichtsführungsstangen **(H)** in den unteren Metallhalter im Korpus **(A)** ein und fixieren Sie diese mit vier Madenschrauben **(P)**, die bereits im unteren Metallhalter vormontiert sind.

! **Achtung: Beachten Sie die Wartungs-Hinweise auf den Seiten 32-33 zur Pflege des Butterflys und der Gewichtsführungsstangen.**

Step 3

Insert the two weight guide rods (H) into the lower metal bracket of the corpus and fix them with four maggot screws (P), which are already attached.

4

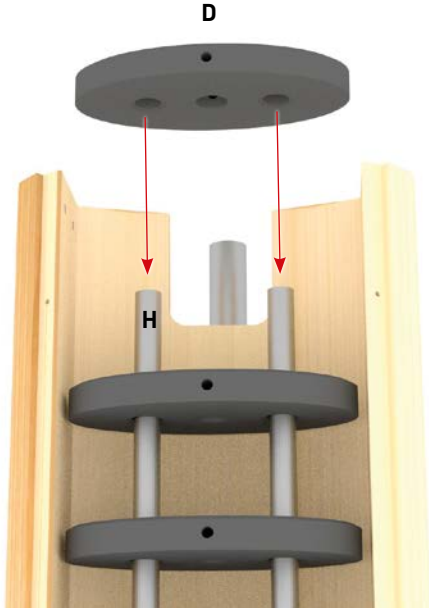

4.1





Schritt 4

Führen Sie nun die 14 Gewichtsplatten **(D)** auf die beiden Gewichtsführungsstangen **(H)**.

ACHTUNG: Die abgerundete Kante der Gewichte sollte oben sein.

HINWEIS: Die Platten wurden in der Herstellung von einer Seite durchgebohrt. Achten Sie daher auch darauf, dass die „schöne“ Seite der Gewichtsplatten nach vorne ausgerichtet ist (sauberes Bohrloch für Pineinfuhr).

Zuletzt führen Sie die Mitnehmerstange **(C)** mit dem Startgewicht und den Zugrollen auf die Gewichtsführungsstangen **(H)**.

HINWEIS: Die Rollen auf der Mitnehmerstange sind in einem Winkel montiert, damit die Seilzugführung reibungslos läuft.

Step 4

Slide the 14 weights (D) onto the weight guide rods (H)

ATTENTION: the slightly rounded edges of the weight plates should be on the upper side. Make sure the proper side of the weight plates (clean drill hole for the pin) points forward.

Now slide the guide rod (C) with the starter weight and pulley onto the weight guide rods (H).

Attention: The guide pulleys on the guide rod weight are assembled in a slight angle. This supports a needless guidance of the cable.

5

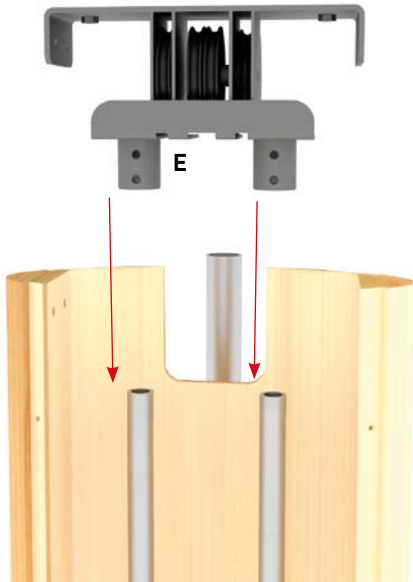

5.1

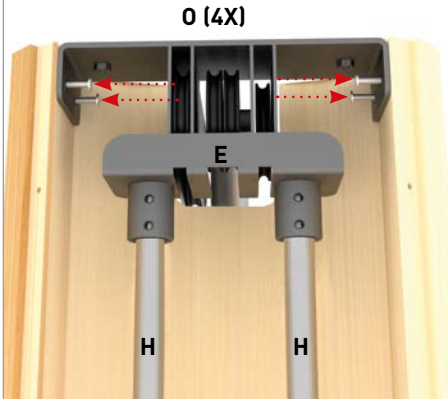

5.2

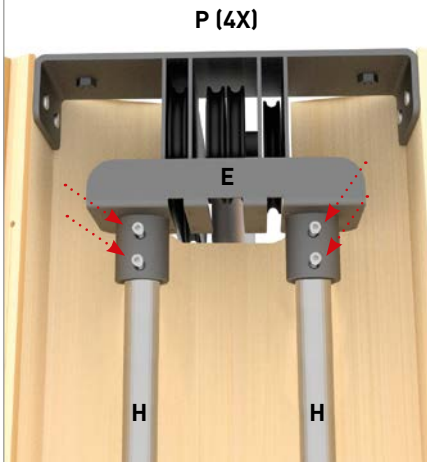

5.3



Schritt 5

Befestigen Sie die Metallverbindungsplatte **(E)**. Achten Sie darauf, dass die Führungsstangen (H) sauber in die Metallverbindungsplatte eingeführt werden.

Schrauben Sie nun die Metallverbindungsplatte **(E)** zuerst mit den 4 x Schrauben **(O)** und anschließend mit den 4 x Madenschrauben **(P)** fest an, die bereits in der Metallverbindungsplatte vormontiert sind.

Legen Sie nun die beiden durchsichtigen Kunststoffdämpfer **(X)** um die Führungsstangen **(H)** und schieben diese zum Anschlag nach oben.

Step 5

Now tighten the Metal bracket (E) by inserting the weight guide rods (H) into the bracket. Tighten the Metal bracket (E) first with the 4x screw (O) and after that with the 4 x maggot screw (P), which are already attached.

Now place the two transparent plastic dampers (X) around the weight guide rods (H).

Slide the dampers (X) all the way up.

6

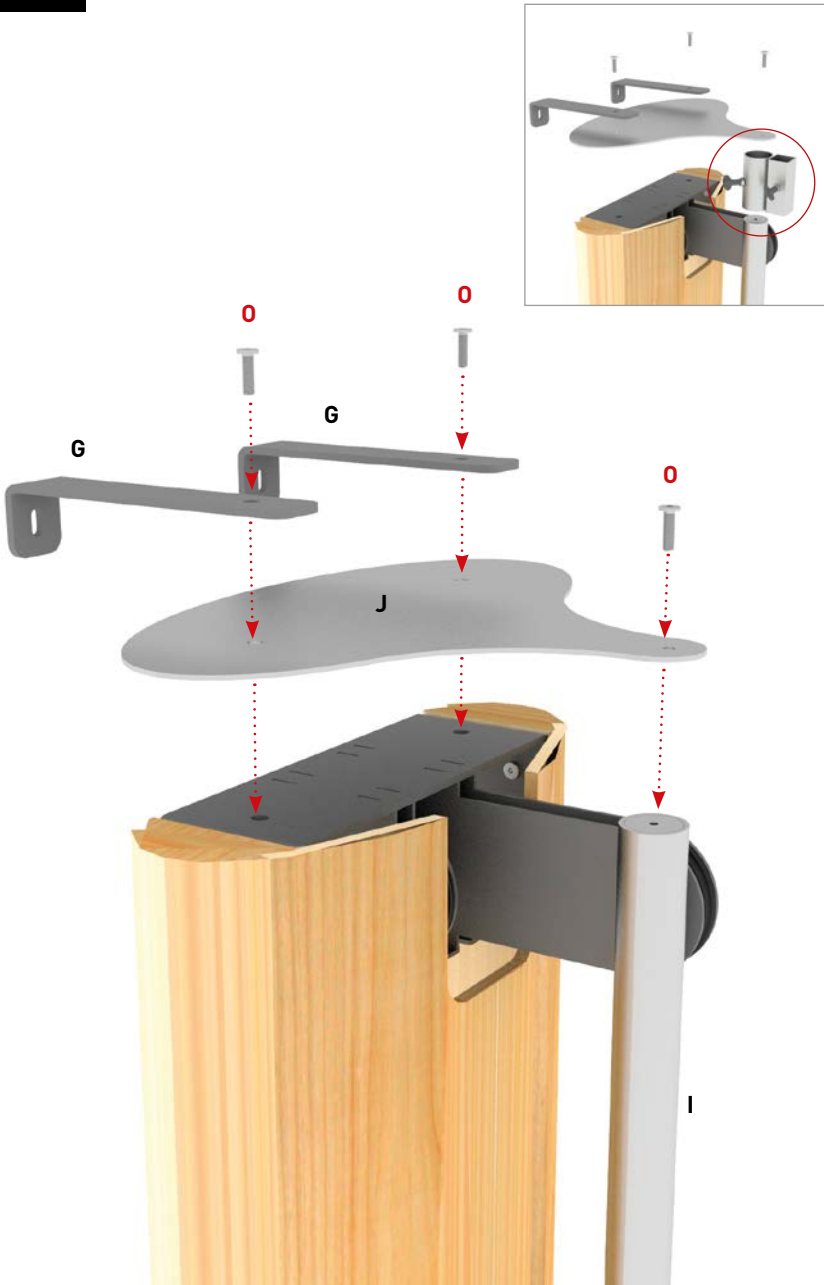



Schritt 6

Nun befestigen Sie die zweite ovale, anthrazite Stahlplatte **(J)** mit den beiden Wandhalterungen **(G)** an der Metallverbindungsplatte **(E)** und der Führungsstange **(I)**.

ACHTUNG: Die Montage an der Führungsstange **(I)** erfolgt nur mit einer Schraube!

Zubehöradapter:

Falls Sie bei Ihrem Produkt den Zubehöradapter benutzen, dann müssen Sie diesen **VOR** der Montage der Stahlplatte (J) über die Führungsstange (I) schieben (s. kleine Abbildung).

Step 6

Take the second anthracite oval plate (J) and fix it together with the wall mounting bracket (G) to the metal bracket (E) and the main guide rod (I)

ATTENTION: The fixation of the main guide rod (I) is executed with only one screw.

If you are using an accessory adapter: Attach the accessory adapter before mounting the oval plate on the metal bracket (small figure).

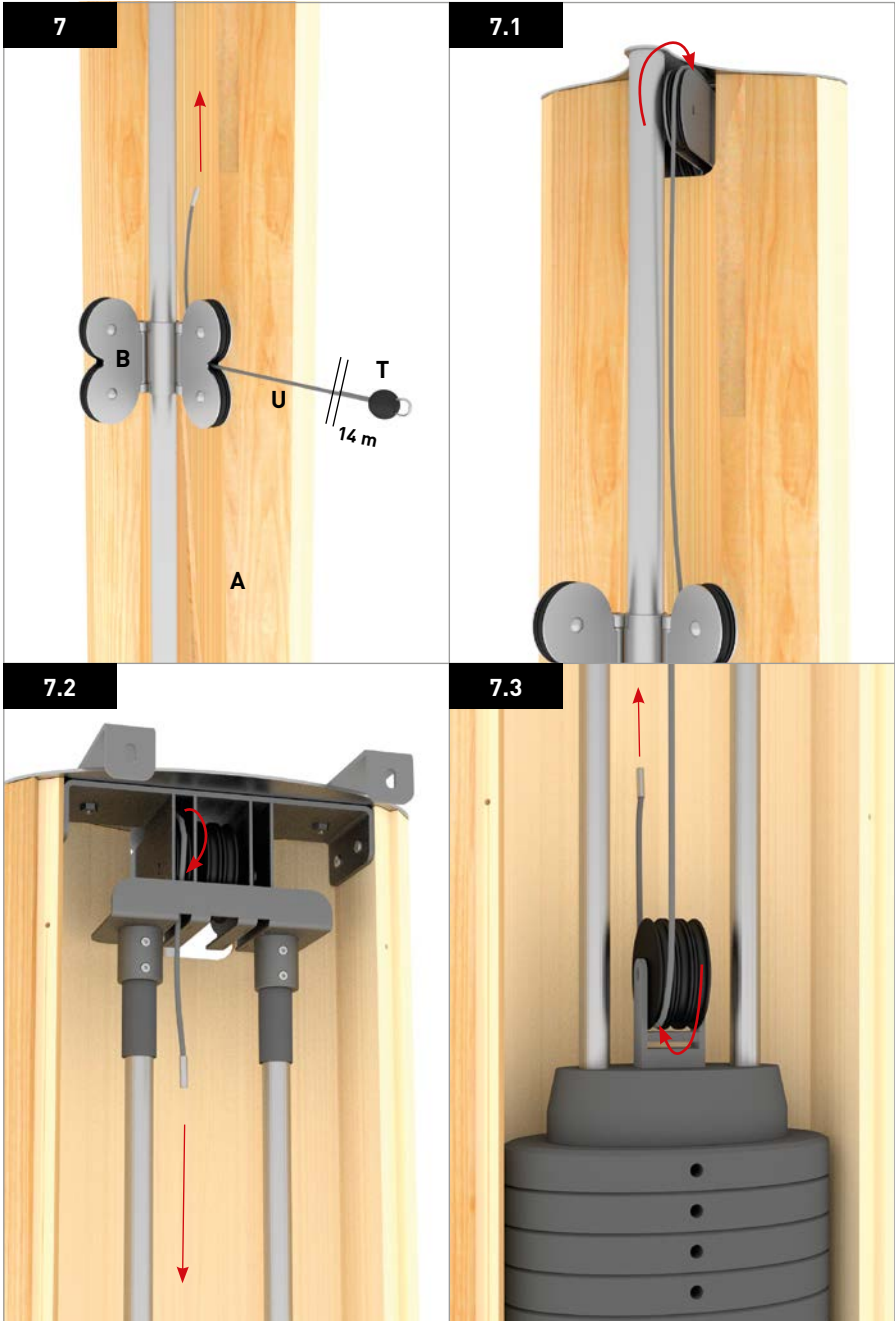

Schritt 7

Es folgt die Montage des Zugseils **(U)**. Führen Sie dieses in den rechten Butterfly **(B)** ein und folgen Sie der Bebilderung.

ACHTUNG: Bei Bild 7.8 ist es zwingend notwendig, dass das Kabel HINTER dem Korpus **(A)** zu dem Spanner **(L)** durchgeführt wird.

ACHTUNG: Bei Bild 7.10 ist es zwingend notwendig, dass das Kabel ZWISCHEN Rolle und Sicherungsstift (im Bild blau dargestellt) durchgeführt wird.

ACHTUNG: Das Aufdrehen des Gummistoppers **(T)** (Bild 8 - 8.1) kann am Besten erfolgen, indem man den Endmetallstift des Führungsseiles mit z. B. einer Flachzange festhält.

Step 7

Now you have to thread the cable onto the pulleys. Start by inserting the cable into the right hand butterfly and then follow the pictures.

ATTENTION: When you reach picture (7.8) you must make sure the cable runs inside the corpus towards the spanner bracket pulley (L).

ATTENTION: The fixation of the rubber stopper (T) at the end of the cable can best be done by holding the end of the cable with pliers.

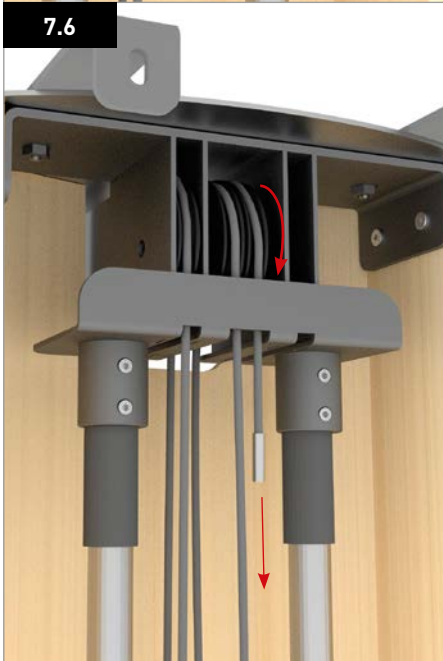
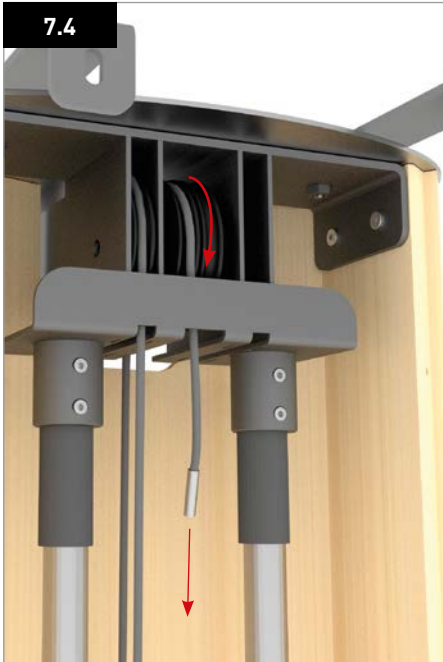

7.8



7.9



7.10



7.11



Kabel zwischen **Sicherungsstift** und Rolle durch führen.
*Make sure to carefully feed the cable between the **bolt** and pulley.*

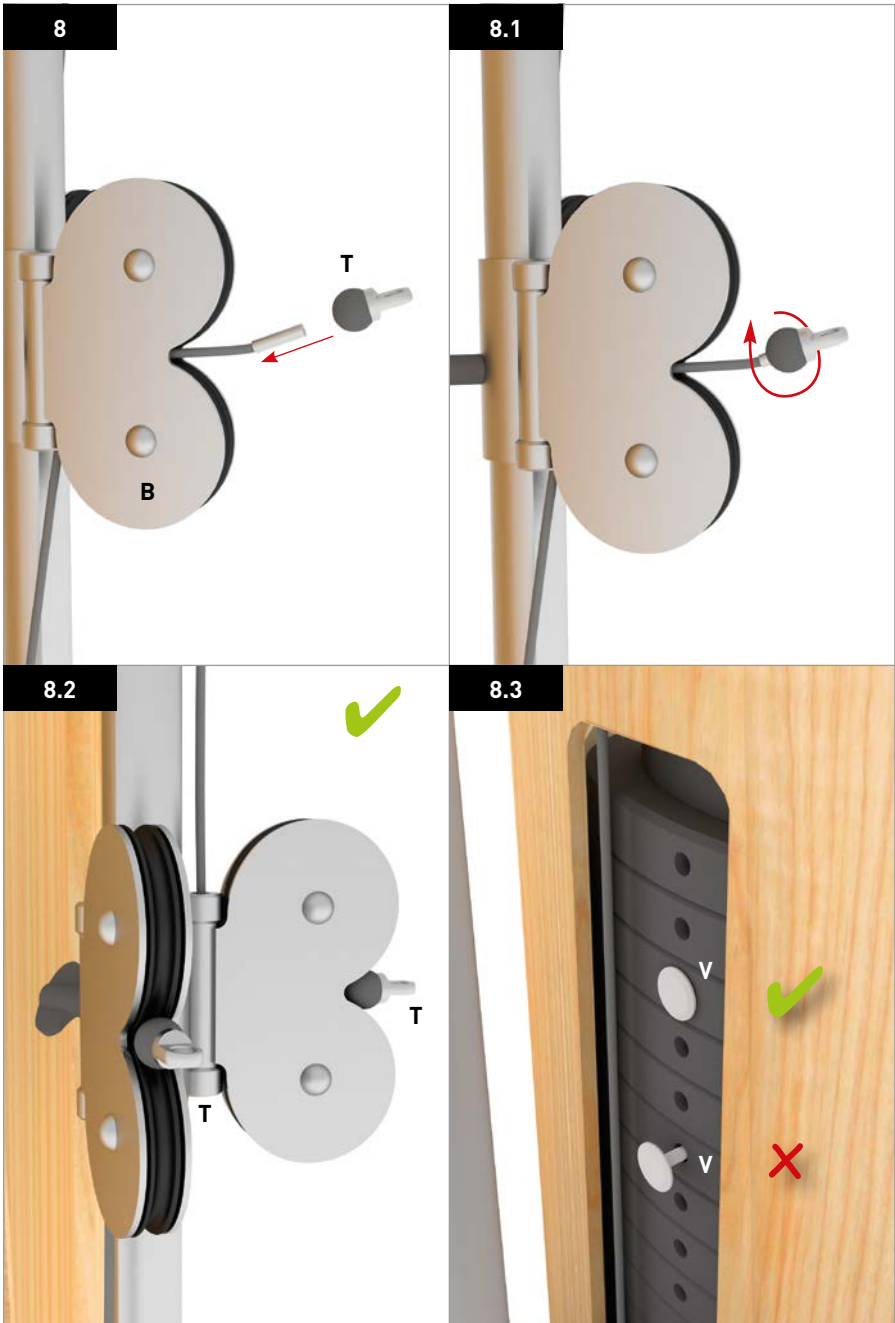

Schritt 8

Spannung des Zugseils:

Nach der Montage des Zugseils kann es sein, dass die Gummistopper **(T)** nicht ganz am Butterfly **(B)** anliegen und lose nach unten hängen. Lösen Sie den Spanner **(L)** (**Abb. 2.1, Seite 14**) und straffen Sie das Seil, bis die Gummistopper **(T)** am Butterfly **(B)** anliegen.

ACHTUNG: Sollten Sie das Seil zu stark spannen, wird die die Führungsstange **(C)** nach oben gezogen und der Gewichtsverstellungs-Pin **(V)** kann nicht mehr in die Gewichte eingeführt werden. Spanner **(L)** nur soweit nach unten führen, bis beide Gummistopper **(T)** am Butterfly **(B)** anliegen.

HINWEIS: Der Gewichtsverstellungs-Pin (V) muss zwingend ganz an die Gewichte angeschoben werden, damit er beim Zug nicht gegen den Korpus schlägt.

Step 8

Spanning the cable:

When you finished threading the cable you might find the ends hanging loose from the butterfly. Loosen the screw from the spanner bracket (L) (figure 2.1, page 14) and slowly move the spanner bracket downwards until both rubber stoppers (T) reach the butterfly. Then tighten the screw of the spanner bracket (L).

ATTENTION: If you span the cable too much, your guide weight will be lifted off and you won't be able to select the weights with the weight pin (V).

ATTENTION: The weight pin (V) needs to be pushed into the weight holes completely to prevent the pin to hit against the corpus.

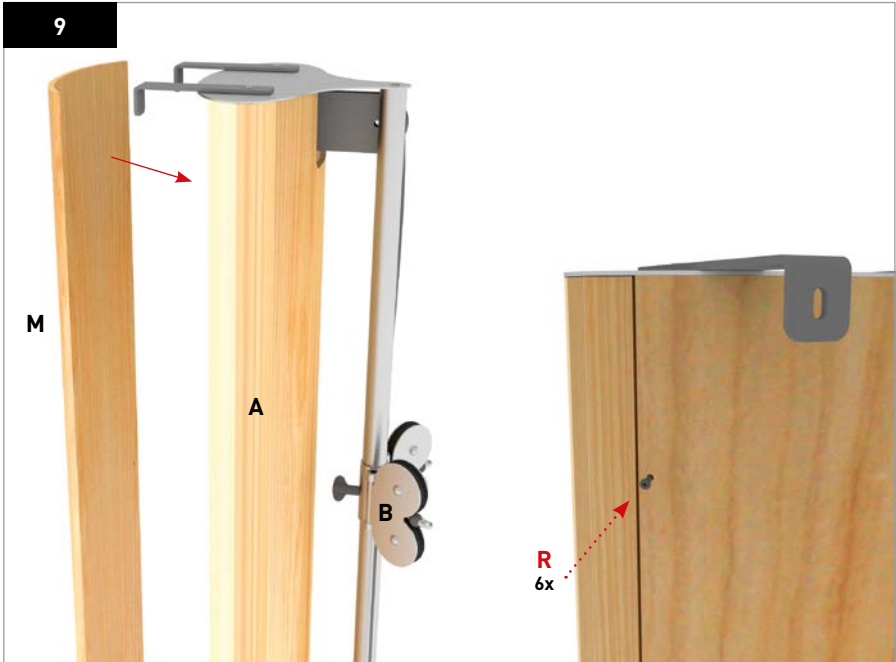



Schritt 9

Bevor Sie das Gerät verschließen, empfehlen wir Ihnen die beiden Gewichtsführungsstangen (**H**) mit unserem speziellen Schmieröl (15.211) einzufetten. Jetzt montieren Sie die Rückplatte (**M**) mit den 6 x kurzen Schrauben (**R**), die bereits in der Rückplatte vormontiert sind.

ACHTUNG: Vor dem Verschließen des Gerätes prüfen Sie nochmals die Freiläufigkeit aller Rollen und die saubere Kabelführung.

Schritt 10

Die Wandmontage des SlimBeams erfolgt mit dem mitgelieferten Montagematerial. Hierzu müssen 2 Löcher mit 10 mm Durchmesser gebohrt werden. Vergewissern Sie sich, dass keine Kabel, Wasser- oder andere Leitungsrohre an dieser Stelle in der Wand verlaufen.

ACHTUNG: Der SlimBeam muss an festen Wänden (Stein, Beton etc.) angebracht werden. Nicht geeignet sind Holz oder Rigipswände.

Das Bohrloch muss eine Tiefe von mind. 70 mm haben.

Step 9

Before you close the machine with the backplate (M), we recommend to oil the weight guide rods (H) with our special lubricat (15.211).

Now fix the back plate (M) with 10 x screws (R).

ATTENTION: Before you close the machine with the back plate make sure the cable runs smoothly and noiseless.

Step 10

You need to mount the SlimBeam to the wall. Use the included fixation material and drill two holes with a 10 mm diameter into a solid wall. Make sure you don't hit a cable, waterpipe or an other pipe that runs in the wall.

ATTENTION: Mount the SlimBeam to a solid wall only (stone, concrete). Don't fix the Slimbeam to plywood or plasterboard wall. The drill hole must have a depth of at least 70 mm.

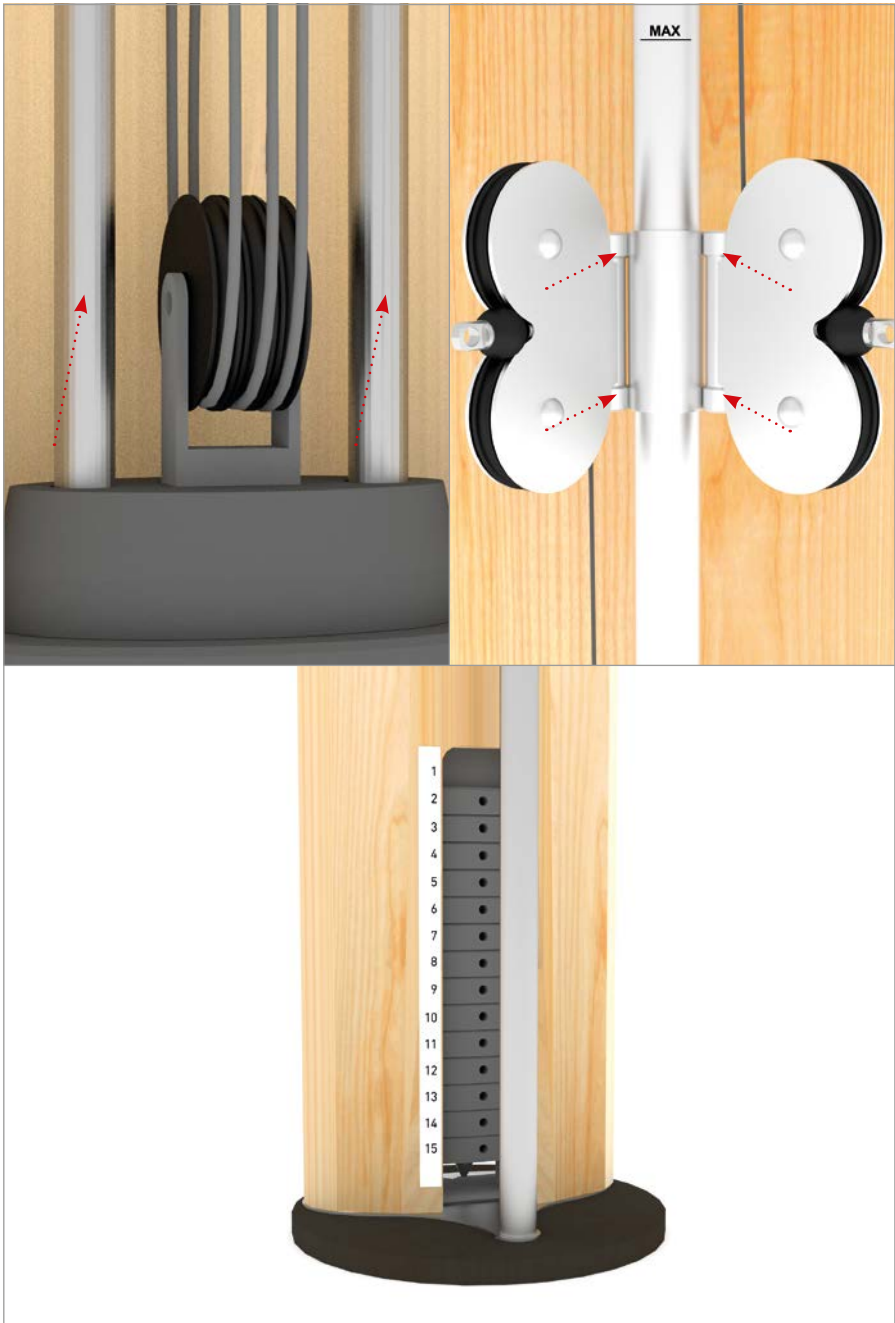



Wartungshinweise

Schmieren Sie regelmäßig den Butterfly sowie die Gewichtsführungsstangen mit unserem Spezial-Schmieröl ein (Bestell-Nr. 15.211). Dies gewährleistet ein ruhiges Training, verhindert Rostbildung, schmiert, schützt vor Anheftung und ist lange wirksam.

Bringen Sie die Gewichtsskala entsprechend der Zeichnung an.
Alternativ ist es möglich die Aufkleber direkt auf die Gewichte zu kleben.

Die maximale Höhe des Butterflys ist mit einem Aufkleber (MAX) gekennzeichnet.
Stellen Sie den Butterfly nicht höher als die Markierung ein.

Maintenance

Before you close the machine with the backplate (M), we recommend to oil the weight guide rods (H) with our special lubricat (Order No. 15.211).

*Place the scale of the weights as shown in the figure.
Do not use the butterfly on a higher position then shown on the sticker.*

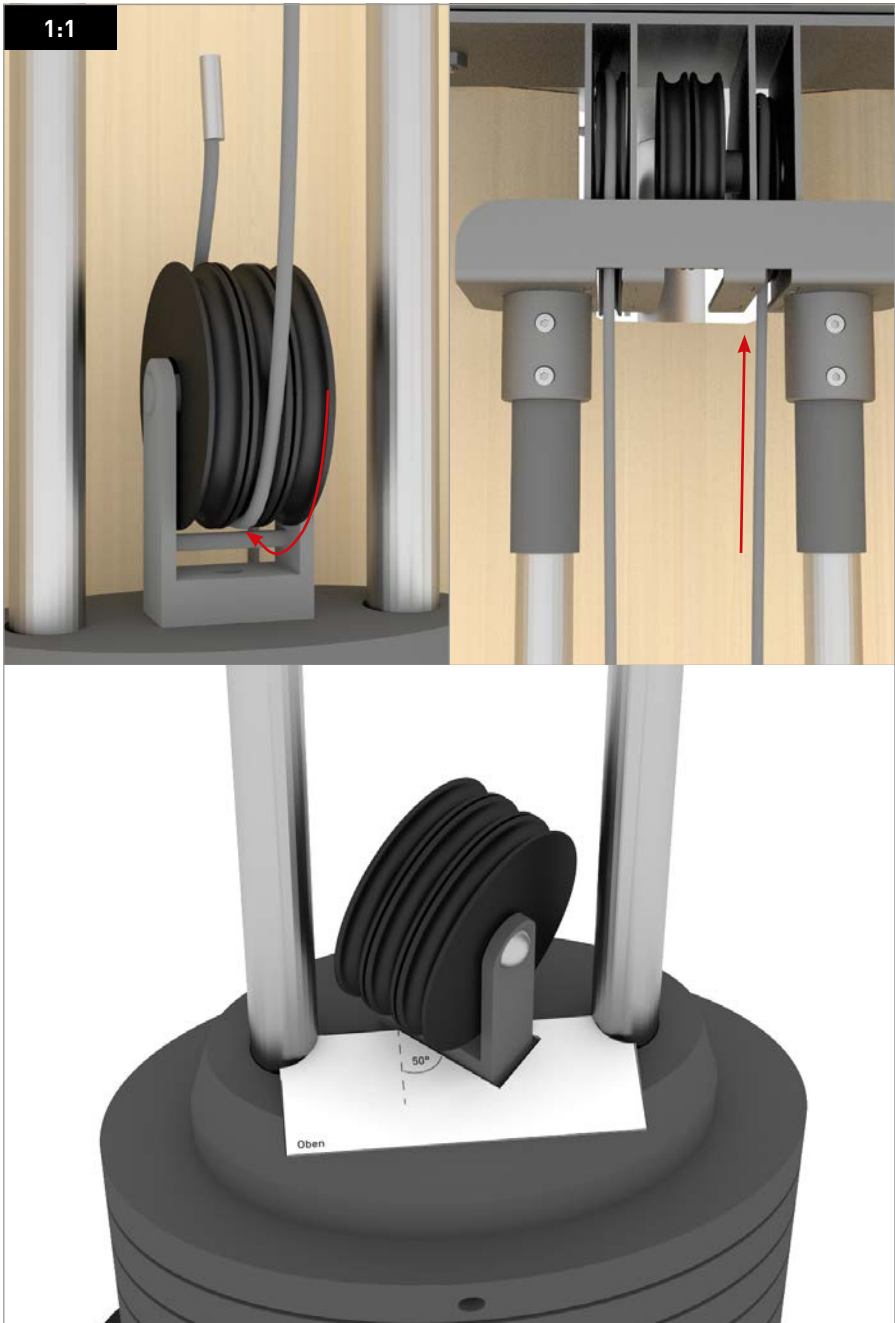

1:1 Übersetzung

Bei der 1:1 Übersetzung wird lediglich die mittlere untere Rolle der Mitnehmerstange (L) genutzt. Das Zugseil wird dann nach oben führend wieder rausgeführt, so wie in Schritt 7.8 beschrieben (Bestell-Nr. 15.206).

Hinweis: Die untere Rolle muss für die 1:1 Übersetzung gedreht werden. Benutzen sie hierfür die unten stehende Schablone:

Schneiden Sie die Schablone aus und platzieren Sie diese wie abgebildet. Richten Sie die Rollen so aus, dass die Halterung in die Öffnung der Schablone passt (50°). Um die Schraube der Rollenhalterung zu lösen, müssen Sie erst die lange Schraube unter den Rollen lösen und herausnehmen. Ziehen Sie anschl. alle Schrauben wieder fest an.

1:1 gearing

When you have the 1:1 gearing cable, make sure you are using the middle pulley on the guide weight. Then continue with step 7.8 (Order No. 15.206).

Cut out the stencil an place as shown. Align the pulleys in such a way that the bracket fits into the opening of the stencil. To release the pulley bracket loosen the long screw underneath the pulley and remove it. When finished, tighten all screws firmly.

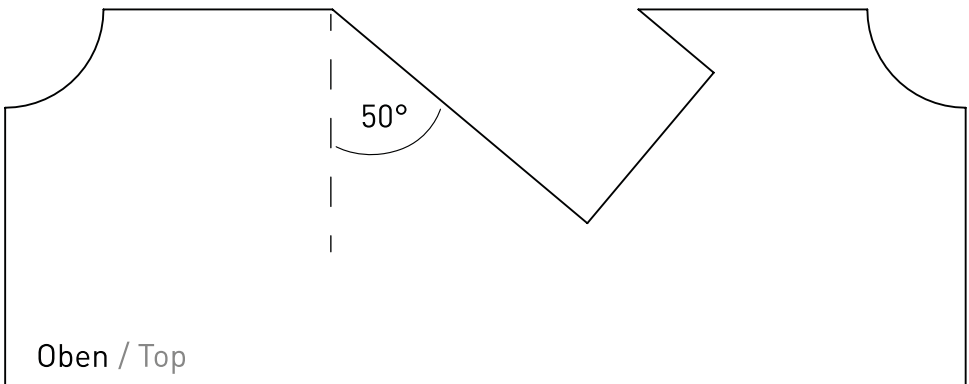

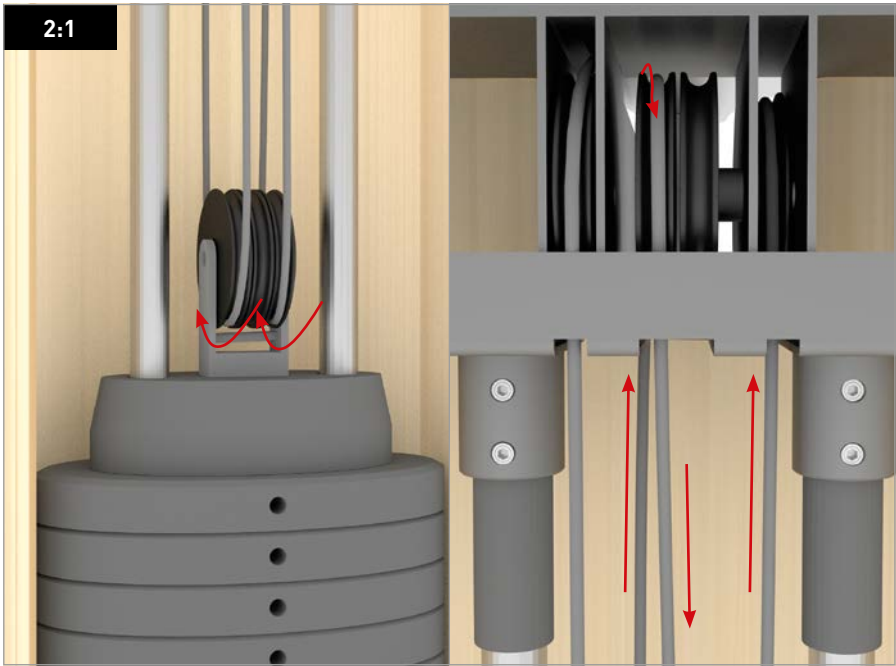

2:1 / 3:1

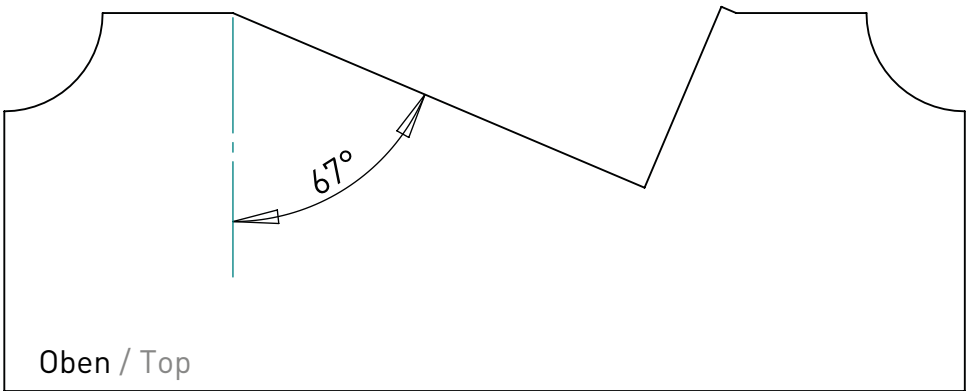

2:1 Übersetzung

Bei der 2:1 Übersetzung werden die beiden äußeren Rollen der Mitnehmerstange (L) genutzt. Führen Sie das Zugseil zu erst um die linke Rolle und gehen Sie dann nach oben zur ersten der mittleren Rollen (s. Abb.). Nachdem das Zugseil um die linke der beiden mittleren Rolle geführt wurde, führen Sie das Zugseil wieder runter. Nun wird die untere rechte Rolle der Mitnehmerstange genutzt.

Anschließend das Zugseil nach vorne führen, so wie in Schritt 7.8 beschrieben (Bestell-Nr. 15.205).

2:1 gearing

When you have the 2:1 gearing cable, make sure you are using the very left and very right pulley on the guide weight.

*Then continue with step 7.8.
(Order No. 15.205)*

The image shows a tablet mounted on a wall next to a wooden pillar, displaying the SimBeam app interface. To the right, two screenshots of the app are shown: the 'Prepare SimBeam' screen and the 'Select a workout' screen.

Prepare SimBeam Screenshot:

Prepare SimBeam

WEIGHT SELECTION: MEDIUM

BUTTERFLY LOCATION: MIDDLE

VIDEO GRAPH: 0 PULLS, 0:20 min left

Select a workout Screenshot:

Select a workout

A workout can be functional or focused on specific body zones.

	FUNCTIONAL	BODY ZONE
5 min Training with warm-up	YES	BACK / CHEST / SHOULDERS
5 min Training with warm-up	NO	BACK / SHOULDERS
5 min Training with warm-up	NO	NECK / CHEST
5 min Training with warm-up	NO	CHEST / SHOULDERS
5 min Training	NO	BACK / CHEST / SHOULDERS
10 min Training	NO	CHEST / SHOULDERS

Main App Interface Screenshot:

5 min Training

Reverse Flys

4 5 6

STOP 2:42/5:00 PAUSE

WORKOUT PERFORMANCE

8.9 pulls/min, 55.8 kg lifted

VIDEO GRAPH

REVERSE FLYS

17 pulls, 0:08 min left

Elektronisches Trainingsleitsystem

Der SlimBeam Korpus ist so vorbereitet, dass er jederzeit mit einer Tablethalterung erweitert werden kann. Sie können Ihr Tablet (nur Android) mit einem USB-Stecker verbinden und die Trainings-App herunterladen.

Während des Trainings werden das eingestellte Gewicht, die Wiederholungen sowie die Zuglänge automatisch erkannt und übersichtlich dargestellt. Jede Übung wird mit einem Video angezeigt.

Die Funktionen im Überblick:

- Gewichtserkennung
- Wiederholungsanzeige
- Gesamtes Gewicht wird angezeigt
- Vorgeschlagene Gewichtseinstellungen
- Vorgeschlagene Butterflyeinstellungen
- Gesamtkörper-Workouts
- Isolierte Übungen
- Anleitende Videos
- Persönliches Profil mit Trainingsübersicht
- Zugverhalten / Zuglänge
- Graphische Darstellung des Zuges

Electronic training system

The SlimBeam's body is manufactured in such a way that the tablet holder can be attached at any time. Use by connecting your tablet (android only) to a USB plug and download the training app. During your workout, the pre-set weight, repetitions and cable length are automatically recognized and clearly displayed. Each exercise is featured by video in detail.

Functions overview:

- *weight recognition*
- *reps display*
- *total weight display*
- *suggested weight settings*
- *suggested butterfly settings*
- *full-body workouts*
- *isolation exercises*
- *instructional videos*
- *personal profile with training overview*
- *android compatible*
- *available separately (p. 30)*
- *cable length / pull history*
- *graphic display of pull*



SlimBeam

Trainingshandbuch
Training manual
Manuel d'entraînement



1-0



1-1



1-2



1-3



1-4



1-5



1-6



1-7



1-8





1-10





2-0



2-1



















2-10



2-11



2-12



2-13



3-0



3-1



3-2



3-3



3-4



3-5



3-6



3-7





4-1



4-2



4-3





4-5











5-0



5-1



5-2



5-3



5-4



5-5



6-0



6-1



6-2



6-3





6-5



K1



K2



K3



K4



K5



C1



C2



C3



C4



C5











Z5











Z10







Z13





Z15



Z16





Physio & Fitness

==== www.sport-tec.de ====

Sport-Tec GmbH
Physio & Fitness
Lemberger Str. 255
D-66955 Pirmasens

Tel.: +49 (0) 6331 1480-0
Fax: +49 (0) 6331 1480-220
E-Mail: info@sport-tec.de
Web: www.sport-tec.de